



**HEAT AND SOUND INSULATING PLATES EURO-TIZOL**

 **TIZOL<sup>®</sup>**



1



2



3



4



5



6



7



8



9



10



11



12

## OBJECTS WITH THE USE OF INSULATION "TIZOL"

### Olympic facilities in Sochi

- Olympic flame bowl (1)
- Olympic stadium "Fisht" (2)
- Sledge-Bobsleigh track "Sankey"
- Ski-biathlon complex "Laura»
- Grand Ice Palace (3)
- Ice Arena "Shayba"

### Administrative and public buildings

- Skolkovo Innovation Center, Moscow (4)
- State residence "Palace of Congresses", St. Petersburg (5)
- Central Stadium "Yekaterinburg Arena", Yekaterinburg (6)
- International Terminal of Koltsovo Airport, Yekaterinburg (7)
- International terminal of Kazan airport, Kazan (8)
- Tolmachevo Airport, Novosibirsk
- State Academic Bolshoi Theater, Moscow (9)
- Museum Complex "Tsaritsyno", Moscow (10)
- Metro station "Parnas", St. Petersburg
- The building of "Gazprom transgazYugorsk", Yugorsk
- Cultural and educational center, Russky Island

### Industrial facilities

- Production buildings "AvtoVAZ", Togliatti (11)
- Beloyarsk NPP, Zarechny
- Yaivinskaya SDPP, Yaiva Village, Perm Krai
- Kashirskaya SDPP, Moscow region
- Kurskaya NPP, Kursk
- Leningradskaya NPP, Sosnovy Bor, Leningrad Region
- North-West TPP, St. Petersburg
- Nizhneartovsk SDPP, Nizhneartovsk
- Sochi TPP, Sochi (12)
- Mutnovskaya Geo PP, Kamchatka

## CONTENT

Objects with insulation "TIZOL" _____	2 and 3 covers
Opening address of the General Director _____	2
Basic terms and properties of thermal insulation _____	3
Company advantages _____	4
Thermal insulation plates EURO-TIZOL _____	6
Main properties of EURO-TIZOL plates _____	7
Pitched roofs, frame walls, partitions, overlappings, floors _____	8
Multilayered walls _____	10
Hinged ventilated facades _____	12
Facades with a thin plaster layer _____	14
Metal sandwich panels _____	16
Flat roofs, interflooroverlappings _____	18
Rules for installation of thermal insulation _____	20

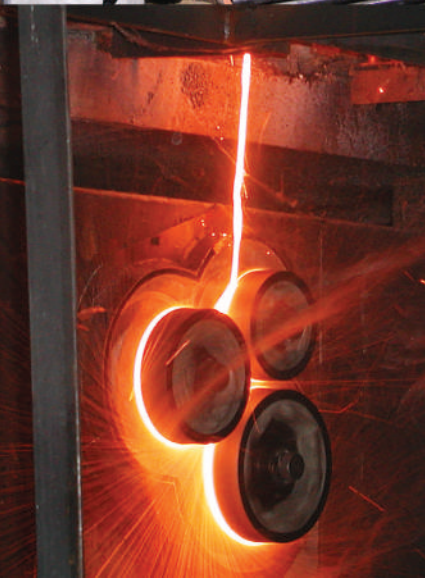

JSC "TIZOL" is one of the recognized leaders among Russian manufacturers of non-combustible heat and sound insulation materials and systems of constructive fire protection based on basalt.

For 70 years, our company has accumulated a unique experience for the entire industry, has created a technical and scientific base for training and the work of highly qualified specialists. Continuous improvement of technology, modernization of production facilities, own source of raw materials, accredited laboratory guarantee the compliance of manufactured products with international quality standards.

The technologies and materials developed at the enterprise are patented and their characteristics are superior to those of the competitors. For example, our fire protection systems are the most effective in Russia and, today, are unique even for Europe. This is confirmed by numerous awards of international and domestic exhibitions.

Every year we produce 25 million square meters or 100 thousand tons of non-combustible heat-sound-proof and fire-proof materials. A developed retail chain stores of dealers ensures timely delivery of our products anywhere in the world. Specialists of the company respectfully treat each partner and create comfortable conditions for cooperation.

The TIZOL brand is a development, stability, decency and, the most important thing is quality.



*Mikhail Grigorievich Mansurov,  
General Director of JSC "TIZOL"  
is an Honored Builder  
and an Honorary Citizen  
of the town of Nizhnyaya Tura*



## BASIC TERMS AND PROPERTIES OF THERMAL INSULATION

### ROCK WOOL

Heat and sound insulation material made from the melt of igneous rocks. The main raw material for the production of rock wool fibers is gabbro-basalt rocks, so rock wool is often called basalt.

### WATER ABSORPTION

Equilibrium hygroscopic humidity of material under certain conditions during the set time. With increase in humidity of heat-insulating materials their heat conductivity increases and heat-insulating properties worsen.

### INCOMBUSTIBILITY

The ability of the material to withstand high temperatures without ignition, damage of structure, strength and other properties. Products made of basalt wool belong to the group of non-combustible materials and have a fire hazard class Km0 (GOST 30244-94).

### THERMAL CONDUCTIVITY

( $\lambda = W / (m \cdot K)$ ) The amount of heat that is transferred per unit area ( $m^2$ ) of a layer of material one meter thick per unit of time with a temperature change of one degree. The heat conductivity is affected by the density, type, size of the material, location of pores, material temperature and humidity.

### WATERPROOFING

Protection of building structures, buildings and structures from the penetration of moisture and aqueous solutions of aggressive substances.

### WINDSCREEN

Protection of heat insulation material and internal elements of the exterior walls of buildings from weathering and heat loss when air passes through an array of cotton wool.

### SOUNDPROOFING

Reduction in the energy of sound waves (noise reduction) penetrating into the premises from outside. The quantitative measure of sound insulation is expressed in decibels.

### SOUND ABSORPTION

The process of converting the energy of sound waves into other types of energy when sound propagates in a medium or when sound is incident on a boundary between two media. The degree of sound absorption is determined by the ratio of the reflected sound energy to the absorbed sound energy.

### VAPOR PERMEABILITY

The ability of the material to pass or to trap the vapor as a result of the difference in partial pressure on the sides of the material. The vapor permeability determines the moisture transfer through the enclosing structure, which is one of the most significant heat transfer factors of the enclosing structure. It is characterized by an isothermal process of moisture transfer determined by the water vapor elasticity gradient.

### SORPTION HUMIDITY

Equilibrium hygroscopic humidity of material under certain conditions during the set time. With increase in humidity of heat-insulating materials their heat conductivity increases and heat-insulating properties worsen.

### CHEMICAL RESISTANCE

The ability of the material to maintain its structure under the influence of various chemical agents. Rockwool is not affected by any oils, solvents, or moderately acidic media. The infiltration of water from rock wool has a neutral chemical reaction, which means that the material does not cause corrosion on the contacting surfaces.

### DENSITY

Characteristics of the material, determined by the ratio of the mass of the material to its volume ( $kg/m^3$ ).

### VAPOR BARRIER

Set of different methods of protecting heat-insulating materials from penetration of vapor and absorption of condensate (dew).

### BIOLOGICAL SAFETY

Stone wool fibers are not a breeding ground for microorganisms and fungi, are not edible for rodents and insects. However, mineral wool fibers are biologically soluble and excreted from the body.



The quality management system of JSC "TIZOL", certified according to the international standard ISO 9001: 2015, guarantees high quality products, technological effectiveness and transparency of all business processes. Availability of own quarry and accredited laboratory equipped with the latest equipment, and highly qualified specialists provide stability of chemical and technical-physical parameters of products that are not inferior in their characteristics to imported analogues

# QUALITY



The "TIZOL" company perfectly knows the technology for production of basalt super-thin fiber and nonflammable insulation which doesn't have world analogs on its basis. Since 2005, "TIZOL" is a recognized leader of the Russian market in the field of development, production and sales of fire proof materials and systems of constructive fire protection. The company is developing new materials based on basalt rocks and technologies for their production

# INNOVATIONS



The company "TIZOL" reacts quickly to changes in the Russian market of building materials. We keep in touch with our customers, we participate in exhibitions, seminars, professional conferences, conduct master classes, presentations and training of employees, provide marketing support of products

# PARTNERSHIP



# ENVIRONMENTAL FRIENDLINESS

The company "TIZOL" pays great attention to the environmental safety of production. In recent years, the enterprise has carried out capital-intensive nature protection measures. "Green" certificate confirms ecological purity of produced materials



# RELIABILITY

Established in 1949 to provide the nuclear industry of the USSR with non-combustible thermal insulation materials, the company "TIZOL" not only managed to survive in the difficult years of "perestroika", but now it maintains a high level of a reliable and stable partner. In the rating of financial stability, the plant received a high score, which indicates the profitability of the organization and its adaptation to fluctuations in the economy. Compliance with all requirements of the current legislation of the Russian Federation in the field of product supply allows the company to participate in government orders, programs and business projects as a reliable partner and supplier



# DEVELOPMENT

"TIZOL" is in the process of continuous modernization of production and business processes. Today the plant has the most modern equipment and technologies therefore the materials "TIZOL" conform to the highest European and Russian standards. They have perfectly proven themselves both in the construction of new buildings with low energy consumption, and in the reconstruction of existing buildings to increase their energy efficiency, heat protection and fire safety

## NONFLAMMABLE HEAT AND SOUND INSULATING EURO-TIZOL PLATES

EURO-TIZOL plates have a universal purpose and are used for heat and sound insulation of all types of building structures: roofs, walls, internal structures, as well as insulation of industrial equipment. Modern European technology allows us to produce up to 60,000 tons of plate products with a density of 25 to 210 kg/m<sup>3</sup> and a thickness of 15 to 250 mm per year. Nonflammable hydrophobic plates are produced both without covering material, and with laminated glass-fibermesh, glass-fiber cloth or foil. The availability of its own raw material base (basalt quarry) ensures the optimal chemical composition of the fiber and the stability of the physical and chemical properties of building insulation. The complex system of control and automation of all production processes, starting with impeccable compliance with the technological formulation and ending with the control of parameters of the finished product, guarantees a consistently high quality of EURO-TIZOL thermal insulation.

At the end of 2011, a new packer for light EURO-LIGHT plates was launched. Now the insulation, which is optimal for low-rise housing construction, is easy to transport and store. Sealed packaging with pre-compression of plates can significantly reduce the volume of packaging and, respectively, save up to 30% the cost of transportation of products, as well as facilitates the storage of plates.

The EURO-TIZOL slabs have been tested in various climatic conditions from Sochi to Yamal and are used on such socially important sites as children's and medical institutions, public catering establishments, apartment houses, museum complexes and architectural monuments, trade and office and entertainment centers, international terminals airports, metro stations, power stations and many others.





## BASIC PROPERTIES OF PLATES "EURO-TIZOL"



### Incombustibility FIRE SAFETY

EURO-TIZOL plates are made on the basis of the melt of basalt rocks, belong to the group of non-combustible materials. EURO-TIZOL plates not only do not burn, but also prevent the spread of fire, preserving the integrity of the structures of buildings.



### Increased DURABILITY

The dimensions and arrangement of fibers in EURO-TIZOL insulation plates provide high strength and resistance to mechanical influences, do not shrink and fulfill their functions throughout the life of the building (not less than 50 years).



### Qualitative THERMAL INSULATION

Low coefficient of thermal conductivity provides high thermal insulation properties, keeping warm in winter and cool in summer. Optimal fiber composition and modern production technology ensure compliance of physical and mechanical parameters with the norms and requirements of the construction industry.



### Environmental SAFETY

Sanitary-epidemiological conclusions confirm the safety of products for housing and civil construction. Materials produced by "TIZOL" can be used in the construction of objects of any functional purpose – from nuclear power plants to medical and children's institutions.



### Effective SOUND INSULATION

Due to the unique fibrous structure, EURO-TIZOL thermal insulation absorbs sound well. When applying EURO-TIZOL in the construction of walls, partitions, ceilings, floors, roofing, the noise level is significantly reduced.



### High MOISTURE RESISTANCE

Hydrophobized plates EURO-TIZOL have high water-repellent properties and practically do not absorb moisture, which allows them to be used in any climatic conditions.



### High ELASTICITY

The material has a high elasticity, restores volume after compression, does not settle, fits snugly to the pillars of the frame.



### Biological SAFETY

EURO-TIZOL plates do not rot, do not mold, are not suitable for food for rodents and insects.



### POWER CONSUMPTION economy

Insulation EURO-TIZOL allows you to protect the heat inside and do not miss the cold outside, resulting in reduced energy costs to maintain a comfortable climate in the room.



### High TECHNOLOGICAL EFFECTIVENESS

Euro-TIZOL plates are easily cut, do not dust, do not break during installation. Have precise geometry and are well placed in structures, which significantly reduces labor costs.



### High VAPOUR PERMEABILITY

EURO-TIZOL plates have good vapor permeability, that is, "breathe", providing optimal conditions inside the building.



### High STRENGTH

The material has high strength. It is a reliable base for a waterproofing carpet or concrete screed.



### Saving DURING TRANSPORTATION

Optimal package sizes provide convenience during loading and unloading operations and maximum use of vehicle capacity. Light, elastic plates of EURO-Light BRANDS are packed in sealed packaging with additional compression – this saves up to 30% on delivery.



### Light WEIGHT MATERIAL

EURO-TIZOL plates are available in a density range from 25 to 210 kg/m<sup>3</sup>, which allows the consumer to choose a suitable brand depending on the purpose and to ensure a minimum load on the protected structure.

## PITCHED ROOFS, FRAME WALLS, PARTITIONS, OVERLAPPINGS, FLOORS

**EURO-LIGHT 25, 30, 35, 40, 50** Non-loading heat and sound insulation layer for light walls, interior partitions, inter floor overlappings, attics, pitched roofs and roof structures, floors,

attic overlappings, ceilings over a cold basement or passage. Heat-insulating layer in cassette, panel and frame enclosure.

BRAND	AVERAGE DENSITY kg/m <sup>3</sup>	DIMENSION, mm			THERMAL CONDUCTIVITY COEFFICIENT W/(m·K)				P*	PP**	PPP***	B*
		length	width	thickness	$\lambda_{10}$	$\lambda_{25}$	$\lambda_A$	$\lambda_B$				
EURO-LIGHT 25	25	1000	500/600	50-250	0,037	0,039	0,040	0,042	–	4	–	1,0
EURO-LIGHT 30	30	1000	500/600	50-250	0,036	0,038	0,039	0,041	–	6	–	1,0
EURO-LIGHT 35	35	1000	500/600	50-250	0,035	0,037	0,039	0,041	–	8	–	1,0
EURO-LIGHT 40	40	1000	500/600	50-250	0,035	0,037	0,038	0,040	–	10	–	1,0
EURO-LIGHT 50	50	1000	500/600	50-250	0,034	0,036	0,038	0,040	–	10	–	1,0

Application temperature from -70 to +400 °C.

P\* – compressive strength at 10% deformation, kPa, not less; PP\*\* – tensile strength perpendicular to the front surfaces, kPa, not less than; PPP\*\*\* – tensile strength parallel to the front surfaces, kPa, not less than; B\* – water absorption for short-term and partial immersion, kg/m<sup>2</sup>, not more.

### INSULATION OF A COLD ATTIC

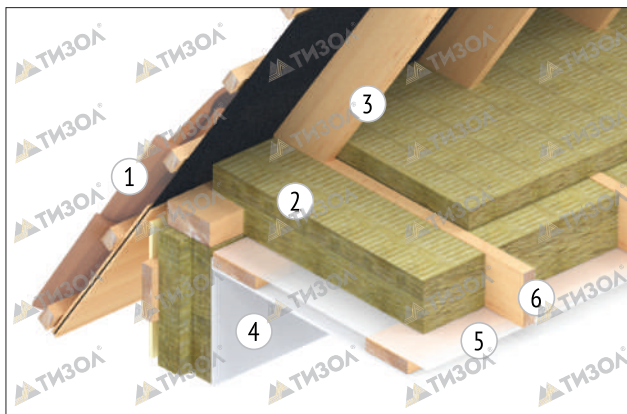

1. tile roof
2. EURO-LIGHT 25, 30, 35, 40, 50
3. rafter foot
4. plasterboard plate
5. vapor barrier
6. floor beam

### INSULATION OF THE MANSARDS / PITCHED ROOF

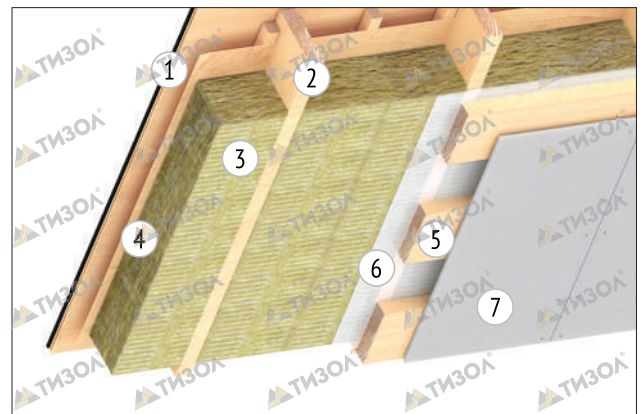

1. bitumen tile
2. rafter foot
3. EURO-LIGHT 25, 30, 35, 40, 50
4. wind protection
5. vapor barrier
6. lathing finish

**FRAME OVERLAPPING INSULATION**

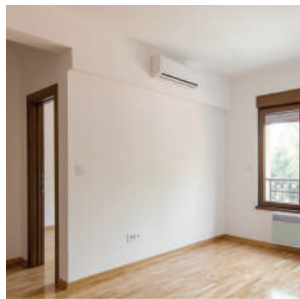
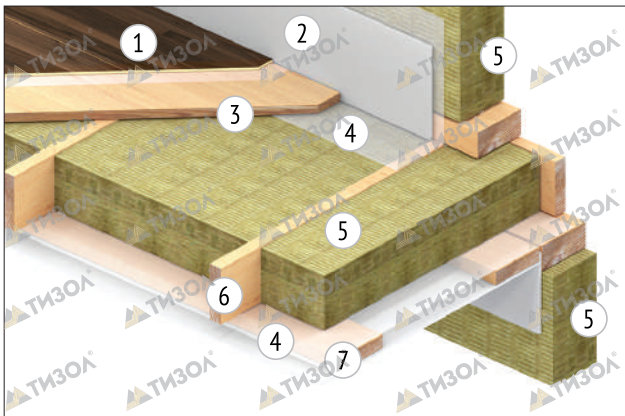

1. floor covering
2. plasterboard plate
3. plywood / OSB
4. vapor barrier
5. EURO-LIGHT 25, 30, 35, 40, 50
6. wooden frame
7. lathing

**FRAME WALL INSULATION**

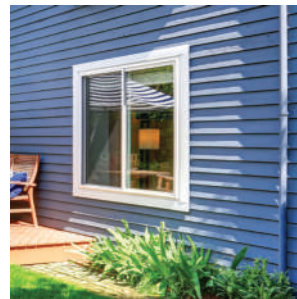
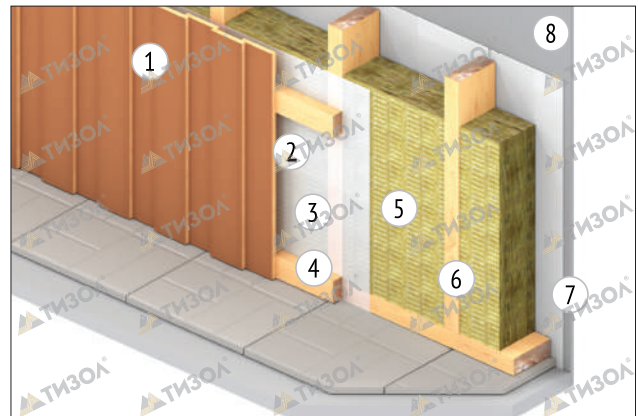

1. finishing of a façade
2. air gap
3. wind protection
4. control bars
5. EURO-LIGHT 25, 30, 35, 40, 50
6. wooden frame
7. vapor barrier
8. interior finish

**SOUND INSULATION OF FRAME WOODEN PARTITION**

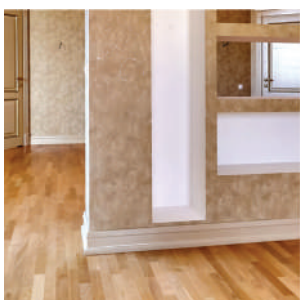
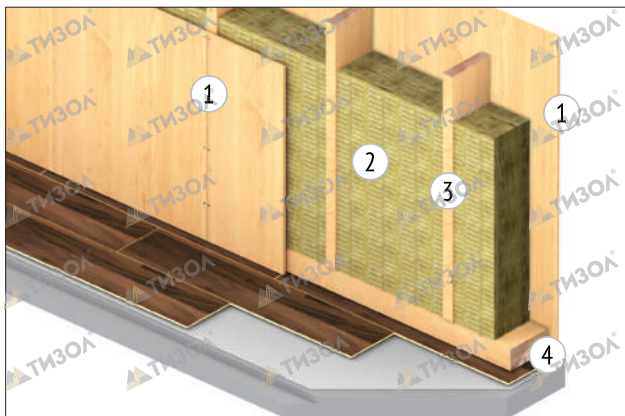

1. panel
2. EURO-LIGHT 40
3. wooden frame
4. plinth

**SOUND INSULATION OF THE FRAME METAL PARTITION**

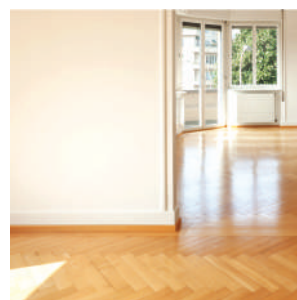
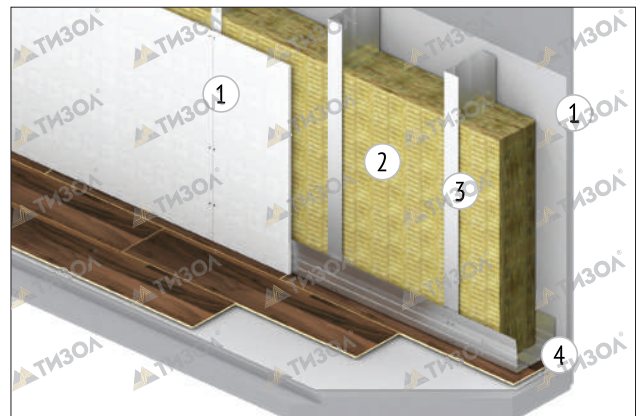

1. plasterboard plate
2. EURO-LIGHT 40
3. metal frame
4. plinth

## LAYERED LAYING OF WALLS

**EURO-LIGHT 50, EURO-BLOCK** the Average heat-insulating layer in three-layer external walls from a brick, light concrete panels or blocks.

BRAND	DENSITY kg/m <sup>3</sup>	DIMENSION, mm			THERMAL CONDUCTIVITY COEFFICIENT W/(m·K)				P*	PP**	PPP***	B*
		length	width	thickness	$\lambda_{10}$	$\lambda_{25}$	$\lambda_A$	$\lambda_B$				
EURO-LIGHT 50	50	1000	500/600	50-250	0,034	0,036	0,038	0,040	–	10	–	1,0
EURO-BLOCK	50-65	1000	500/600	50-250	0,035	0,036	0,038	0,040	–	10	–	1,0

Application temperature from -70 to +400 °C.

P\* – compressive strength at 10% deformation, kPa, not less; PP\*\* – tensile strength perpendicular to the front surfaces, kPa, not less than; PPP\*\*\* – tensile strength parallel to the front surfaces, kPa, not less than; B\* – water absorption for short-term and partial immersion, kg/m<sup>2</sup>, not more.

### INSULATION WITH BRICK FACING

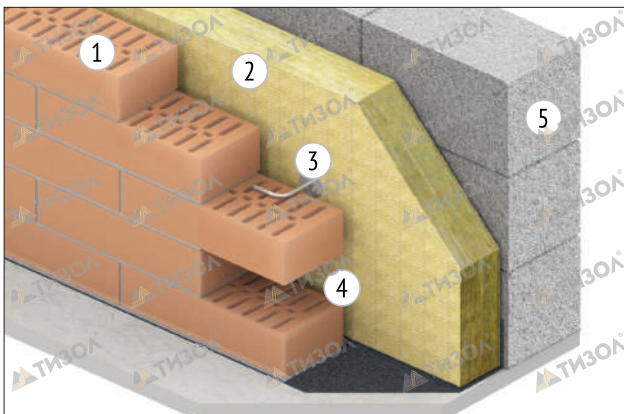

1. brick laying
2. EURO-LIGHT 50, EURO-BLOCK
3. flexible connection
4. air gap inner layer



# HINGED VENTILATED FACADES

**EURO-VENT N** Inner layer with double-layer insulation in hinged facade systems with air gap (in combination with EURO-VENT, EURO-VENT V plate) or independently with single-layer insulation in low-rise buildings.

**EURO-VENT** Thermal insulation layer for single-layer insulation in ventilated facade systems with air gap. Outer layer with two-layer insulation in hinged facade systems with air gap (in combination with the EURO-VENT N plate).

**EURO-VENT V** Outer layer with double-layer insulation in hinged facade systems with air gap (in combination with EURO-BEHT N, EURO-VENT plate).

Thermal insulation layer with single-layer insulation in hinged facade systems with air gap. As a heat-insulating layer in facade systems with a thick plaster layer.

BRAND	DENSITY kg/m <sup>3</sup>	DIMENSION, mm			THERMAL CONDUCTIVITY COEFFICIENT W/(m·K)				P*	PP**	PPP***	B*
		length	width	thickness	$\lambda_{10}$	$\lambda_{25}$	$\lambda_A$	$\lambda_B$				
EURO-VENT N	40-50	1000	500/600	50-250	0,035	0,036	0,038	0,040	-	10	-	1,0
EURO-VENT	70-90	1000	500/600	30-250	0,034	0,036	0,038	0,040	18	-	7	1,0
EURO-VENT V	90-110	1000	500/600	30-250	0,035	0,037	0,039	0,041	22	-	10	1,0

Application temperature from -70 to +400 °C.

P\* – compressive strength at 10% deformation, kPa, not less; PP\*\* – tensile strength perpendicular to the front surfaces, kPa, not less than; PP\*\*\* – tensile strength parallel to the front surfaces, kPa, not less than; B\* – water absorption for short-term and partial immersion, kg/m<sup>2</sup>, not more.

## ONE LAYER INSULATION

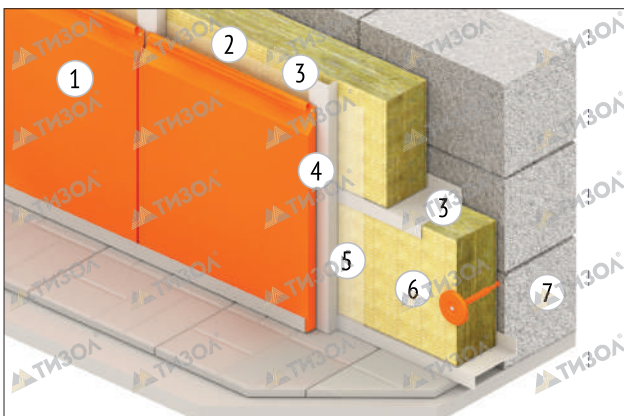

1. facing
2. air gap
3. subsystem (support bar and vertical guides)
4. fastening element
5. wind protection (if necessary)
6. EURO-VENT, EURO-VENT V
7. supporting structure

## TWO LAYERS INSULATION

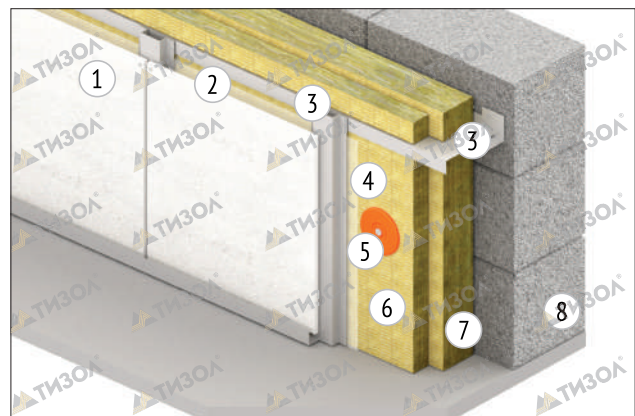

1. facing
2. air gap
3. subsystem (support bar and vertical guides)
4. wind protection (if necessary)
5. fastening element
6. EURO-VENT, EURO-VENT V
7. EURO-VENT N
8. supporting structure

## FACADES WITH A THIN PLASTER LAYER

**EURO-FASAD, EURO-FASAD OPTIMA, EURO FASAD UNIVERSAL** Thermal insulation layer for facade systems with a thin outer plaster layer, systems with ceramic tiles.

For arranging of bafflers, including fire-prevention, and also strips for framing window and door apertures in facade systems.

BRAND	DENSITY kg/m <sup>3</sup>	DIMENSION, mm			THERMAL CONDUCTIVITY COEFFICIENT W/(m·K)				P*	PP**	PPP***	B*
		length	width	thickness	$\lambda_{10}$	$\lambda_{25}$	$\lambda_A$	$\lambda_B$				
EURO-FASAD	140-160	1000	500/600	30-250	0,036	0,038	0,040	0,042	50	–	15	1,0
EURO-FASAD OPTIMA	110-130	1000	500/600	30-250	0,035	0,037	0,039	0,041	40	–	15	0,75
EURO FASAD UNIVERSAL	120-140	1000	500/600	30-250	0,035	0,037	0,039	0,041	45	–	17	0,75

Application temperature from -70 to +400 °C.

P\* – compressive strength at 10% deformation, kPa, not less; PP\*\* – tensile strength perpendicular to the front surfaces, kPa, not less than; PP\*\*\* – tensile strength parallel to the front surfaces, kPa, not less than; B\* – water absorption for short-term and partial immersion, kg/m<sup>2</sup>, not more

### LIGHT PLASTER SYSTEM

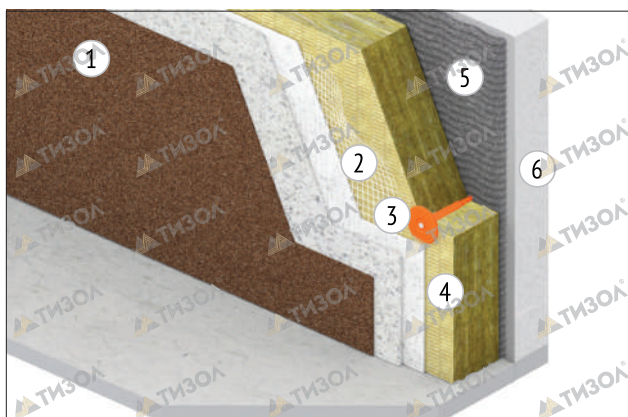

1. plaster
2. basic reinforced layer
3. fastening element
4. EURO-FASAD, EURO-FASAD OPTIMA, EURO FASAD UNIVERSAL
5. adhesive composition
6. supporting structure

### WITH CERAMIC TILE FACING

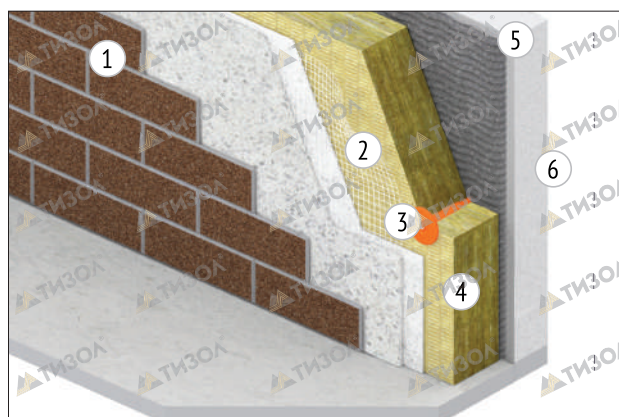

1. decorative tile
2. basic reinforced layer
3. fastening element
4. EURO-FASAD, EURO-FASAD OPTIMA, EURO FASAD UNIVERSAL
5. adhesive composition
6. supporting structure

# METAL SANDWICH PANELS

**EURO SANDWICH S** Thermal insulation layer for the production of wall sandwich panels with thin-sheet metal facing. Wall sandwich panels are used for the construction of enclosing structures of prefabricated buildings on the basis of the metal frame.

**EURO SANDWICH K** Thermal insulation layer for the production of roofing sandwich panels with a thin-sheet metal facing. Roofing sandwich panels are used for the construction of roofs of prefabricated buildings on the basis of the metal frame.

BRAND	DENSITY kg/m <sup>3</sup>	DIMENSION, mm			THERMAL CONDUCTIVITY COEFFICIENT W/(m·K)				P*	PP**	PPP***	B*
		length	width	thickness	$\lambda_{10}$	$\lambda_{25}$	$\lambda_A$	$\lambda_B$				
EURO SANDWICH S	95-115	order	order	35-250	0,040	0,042	–	–	65	–	100	1,0
EURO SANDWICH K	125-155	order	order	35-250	0,042	0,044	–	–	100	–	120	1,0

Application temperature from -70 to +400 °C.

P\* – compressive strength at 10% deformation, kPa, not less; PP\*\* – tensile strength perpendicular to the front surfaces, kPa, not less than (tests shall be carried out on the application of load and heat flow along the fibers); PP\*\*\* – tensile strength parallel to the front surfaces, kPa, not less than; B\* – water absorption for short-term and partial immersion, kg/m<sup>2</sup>, not more

## INSULATION WITH METAL SANDWICH PANELS

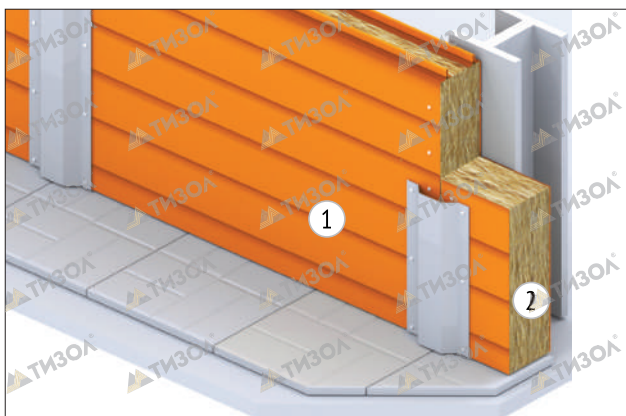

1. metal plating (profiled sheet)
2. EURO SANDWICH S, EURO SANDWICH K

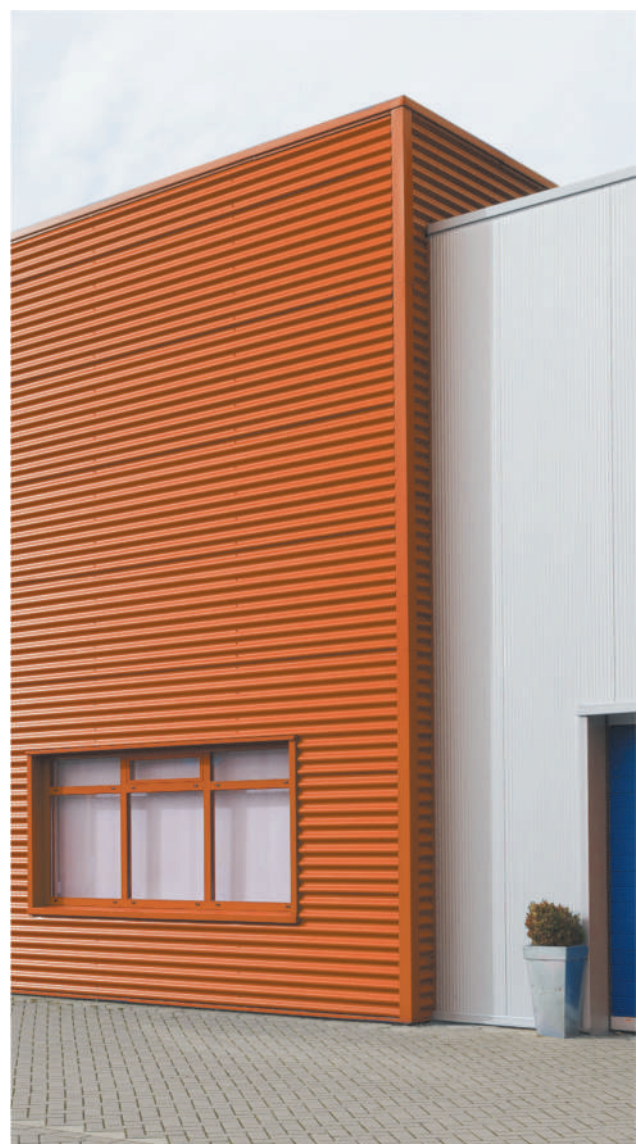

## FLAT ROOFS, INTER FLOOR OVERLAPPING

**EURO-ROOF N, EURO-ROOF** The lower heat-sound-insulating layer in multi-layer roofing on metal profiled flooring or concrete base for the installation of roofs without screeds (using in combination with the EURO-ROOF, EURO-ROOF V, EURO-ROOF V Super) or as an independent heat-insulating layer with screed. Heat and sound insulation of floors, interfloor and attic overlapping, overlapping above the cold cellar with screed. Thermal insulation of industrial equipment, refrigeration facilities.

**EURO-ROOF, EURO-ROOF V, EURO-ROOF V Super** The upper heat-insulating layer for single-layered or multi-layered (in combination with the EURO-RUF N plate) structures, coatings on metal profiled flooring or concrete base for the installation of roofs without screed, and also for heat and sound insulation of floors, inter floor overlapping, overlapping above the cold cellar with screed.

BRAND	DENSITY kg/m <sup>3</sup>	DIMENSION, mm			THERMAL CONDUCTIVITY COEFFICIENT W/(m·K)				P*	PP**	PPP***	B*
		length	width	thickness	$\lambda_{10}$	$\lambda_{25}$	$\lambda_A$	$\lambda_B$				
EURO-ROOF N	100-120	1000	500/600	30-250	0,035	0,037	0,040	0,041	32	–	10	1,0
EURO-ROOF	150-170	1000	500/600	40-200	0,036	0,039	0,041	0,043	60	–	12	1,0
EURO-ROOF V	170-190	1000	500/600	30-150	0,036	0,039	0,041	0,044	80	–	15	1,0
EURO-ROOF V SUPER	190-210	1000	500/600	30-100	0,038	0,040	0,042	0,044	90	–	15	1,0

Application temperature from -70 to +400 °C.

P\* – compressive strength at 10% deformation, kPa, not less; PP\*\* – tensile strength perpendicular to the front surfaces, kPa, not less than; PP\*\*\* – tensile strength parallel to the front surfaces, kPa, not less than; B\* – water absorption for short-term and partial immersion, kg/m<sup>2</sup>, not more

### SINGLE-LAYER ROOFING SYSTEM

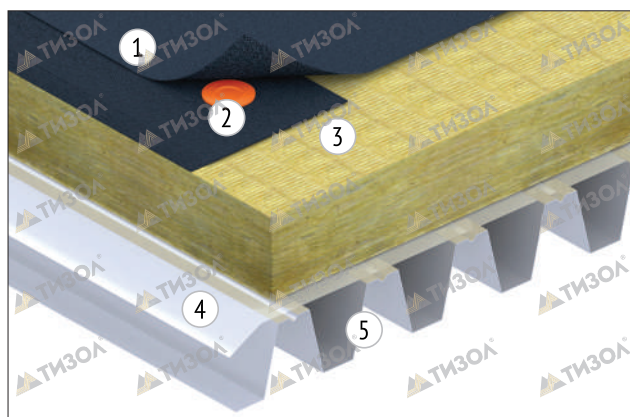

1. waterproofing layer
2. fastening element
3. EURO-ROOF, EURO-ROOF V, EURO-ROOF V Super
4. vapor barrier
5. base

### TWO-LAYER ROOFING SYSTEM

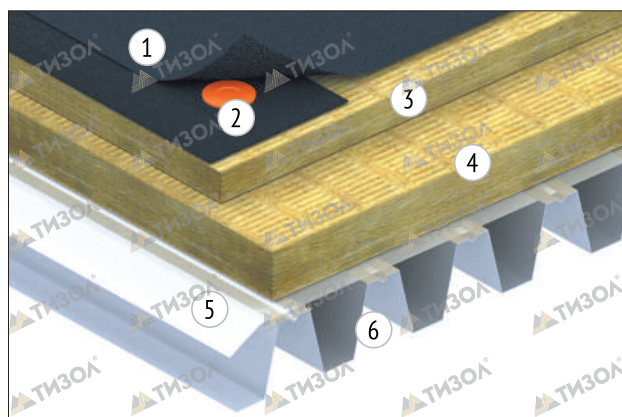

1. waterproofing layer
2. fastening element
3. EURO-ROOF, EURO-ROOF V, EURO-ROOF V Super
4. EURO-ROOF N
5. vapor barrier
6. base



**INSULATION UNDER SCREED ON THE REINFORCED CONCRETE PLATE**

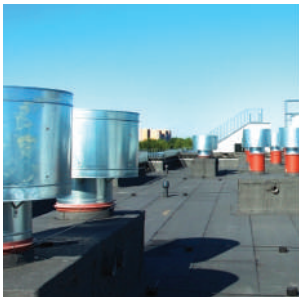
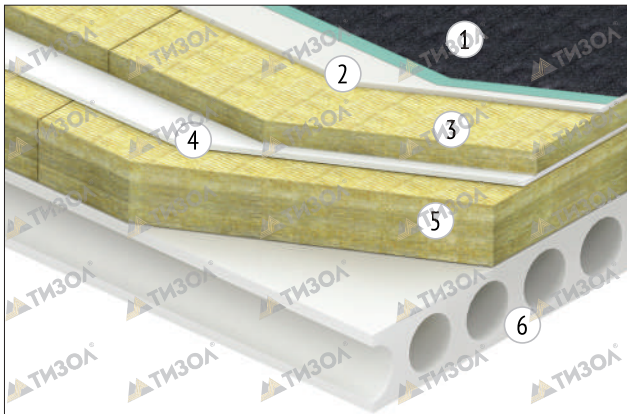

1. damp-proof course
2. sand cement screed or sheet backing coat
3. EURO-ROOF, EURO-ROOF V, EURO-ROOF V Super
4. screed
5. EURO-ROOF N
6. reinforced concrete plate

**DOUBLE LAYER INSULATION ON REINFORCED CONCRETE PLATE**

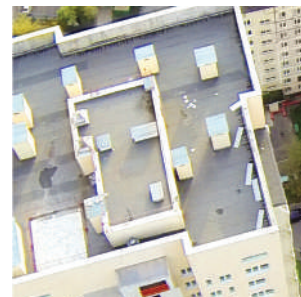
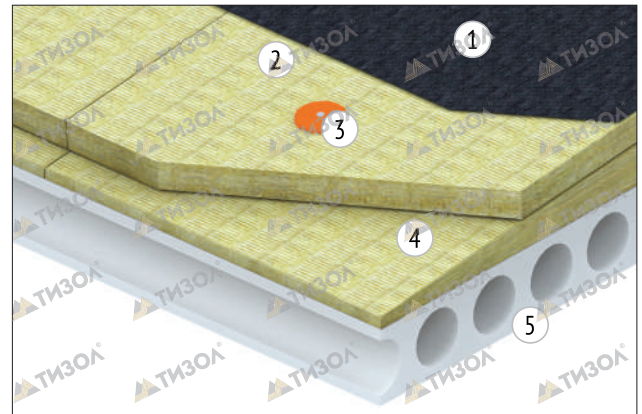

1. damp-proof course
2. EURO-ROOF, EURO-ROOF V, EURO-ROOF V Super
3. fastening element
4. EURO-ROOF N (EURO-ROOF slope)
5. reinforced concrete plate

**INSULATION OF INTERFLOOR OVERLAPPING ON REINFORCED CONCRETE PLATE**

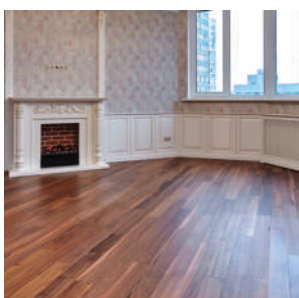
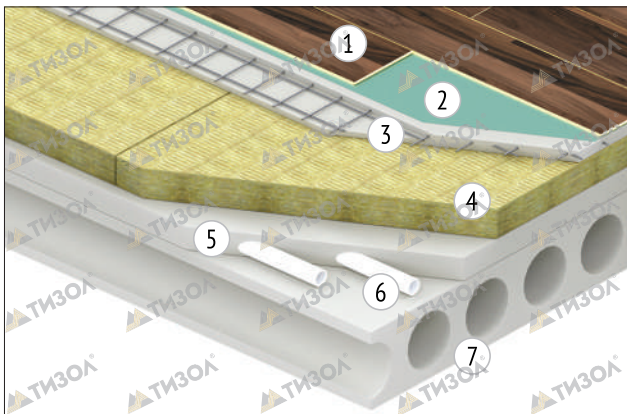

1. flooring
2. backing layer
3. reinforced leveling layer
4. EURO-ROOF N, EURO-ROOF, EURO-ROOF V, EURO-ROOF V Super
5. leveling layer
6. communications reinforced concrete plate
7. reinforced concrete plate

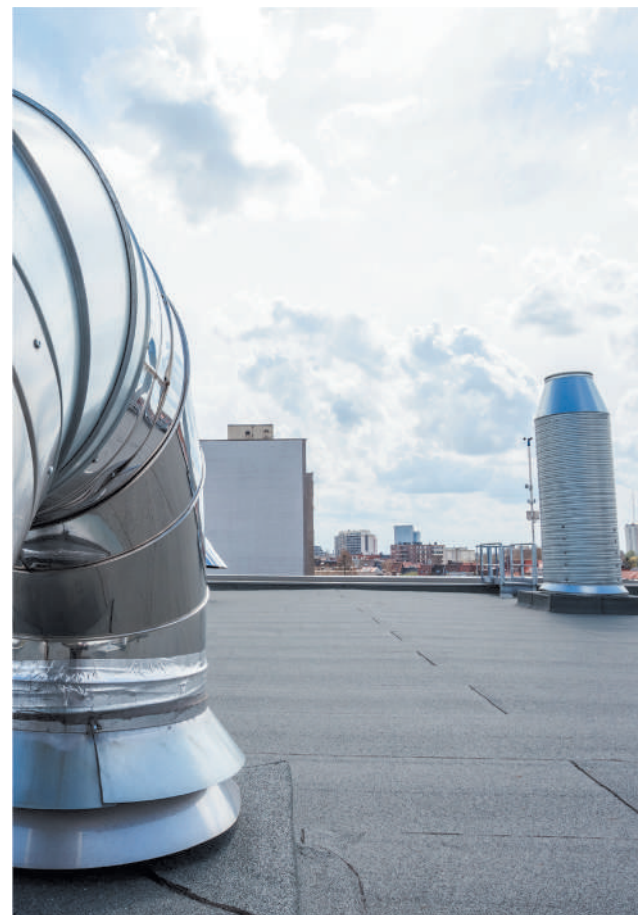

## RULES OF INSTALLATION OF THERMAL INSULATION

1. Thermal insulation must be tight and securely adjacent to the insulated surface of the structure.

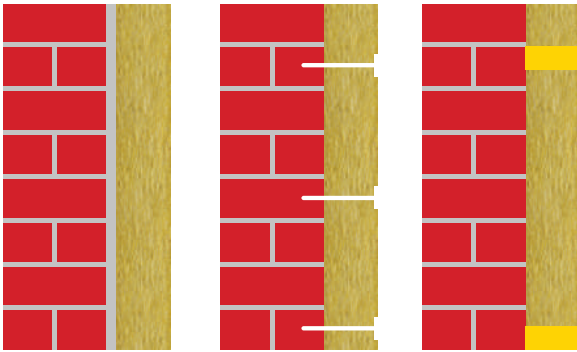

2. Plates should be mounted with displacement relative to each other.

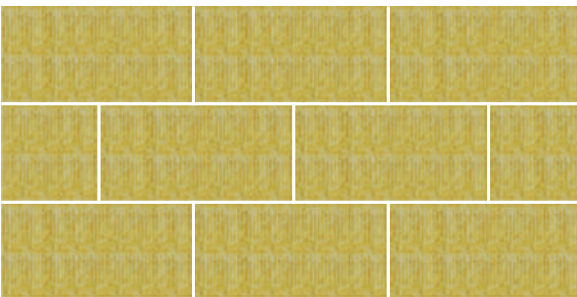

3. When installing a two-layer thermal insulation system, the slabs of the outer layer must overlap the joints of the inner layer of thermal insulation.

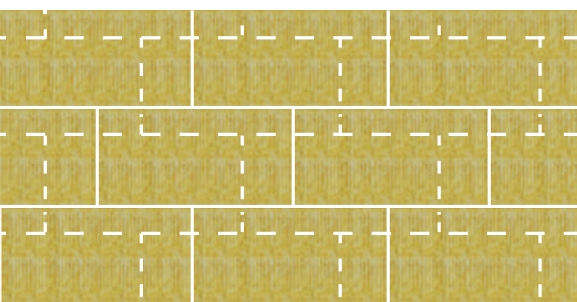

4. Slots and voids should be sealed with stone wool scraps.



5. Plates of the thermal insulation mounted in a framework shall completely fill it.

For wooden and metal structures:

EURO-LIGHT plate 30,35,40,50 (1000x600 mm) is placed between the struts with side of 600 mm.

The distance between the struts of the frame 580 mm.

Wooden structure

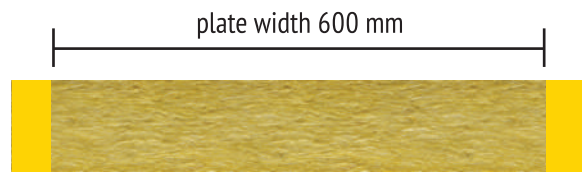

Metal structure

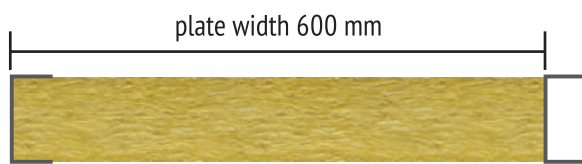

6. To protect the ventilated facade constructions from blowing, the use of EURO-VENT, EURO-VENT V plates is recommended. The use of these plates allows the implementation of a ventilated facade system without wind protection.

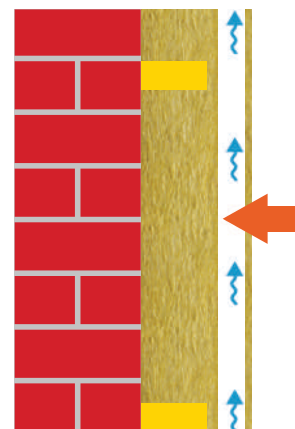

7. When insulating of the flat roof to prevent the load on the heater you should begin the laying from the far zones (corners).



13



14



15



16

## OBJECTS WITH INSULATION "TIZOL"

### Shopping and entertainment centers, business centers, hotels

Social and business complex "Lakhta-center", St. Petersburg

International exhibition center "Crocus Expo", Moscow (13)

"Mercury City Tower" international business center "Moscow-City", Moscow, Russia (14)

"Arena Uralets" cultural and entertainment complex, Yekaterinburg

Sports and entertainment complex "Ice Palace", Yekaterinburg

Aquapark "Limpopo", Yekaterinburg

Hotel Hyatt Regency, Yekaterinburg (15)

Shopping center "Megamart", Kaliningrad

Shopping and entertainment center "Greenwich", 4th construction stage, Ekaterinburg (16)

Shopping and entertainment center "Alatyr", Ekaterinburg

Shopping and entertainment center "Rodnik", Chelyabinsk

BC "London", Nizhny Novgorod

Shopping Center "Petrovsky Fort", St. Petersburg (17)

Shopping center "Mega", Yekaterinburg (18)



17



18

### Housing construction

Residential Complex "Malevich", Yekaterinburg (19)

Residential Complex «Solnechny Gorod», Perm (20)

Residential Complex "Tikhiy Bereg", Yekaterinburg

Residential Complex "Sedmoe Nebo" Nizhny Novgorod

Residential Complex "Silver Quartet", Moscow



19



20

### Foreign objects

Tianwan NPP, China (21)

Bushehr NPP, Iran (22)

Kudankulam NPP, India

"Ice Arena", Almaty (23)

Expo 2017, Astana (24)

Residential district of Sayala, Almaty

"Department of state revenue", Aktau

Shopping and entertainment center "Moscow", Almaty



21



24



23



22



Joint-stock company "TIZOL", 59, Malyshev St., Nizhnaya Tura, 624223, Sverdlovsk region, Russia

Fireproof materials

(34342) 2-62-70, 2-61-35

oom@tizol.com

Building insulation

2-63-11 (12, 13, 14)

market@tizol.com

Technical insulation

2-62-05

oti@tizol.com

Marketing and advertising

2-51-97, 2-62-11

reklama@tizol.com

[www.tizol.com](http://www.tizol.com)



ISO 9001 : 2015  
Quality management system



 **TIZOL**<sup>®</sup>